

# BOSS™

MARINE

## Co-extruded Fender

### Simple, One-Piece Design

By utilising State-of-the-art co-extrusion technology and materials; Boss is able to create a superior weld between the flexible top and rigid base resulting in a Fender that is less prone to splitting where the 2 materials intersect.

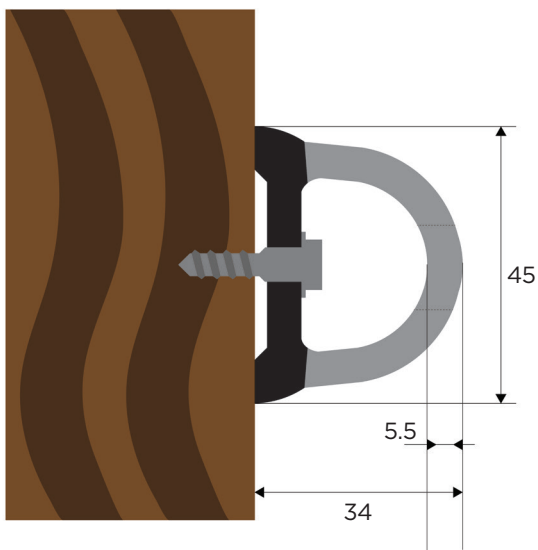

\*Can be used as a direct replacement for the Bellingham fender system. Fender is stocked in 3 meter lengths without holes. Custom lengths and drilling available. Minimum order quantities apply.

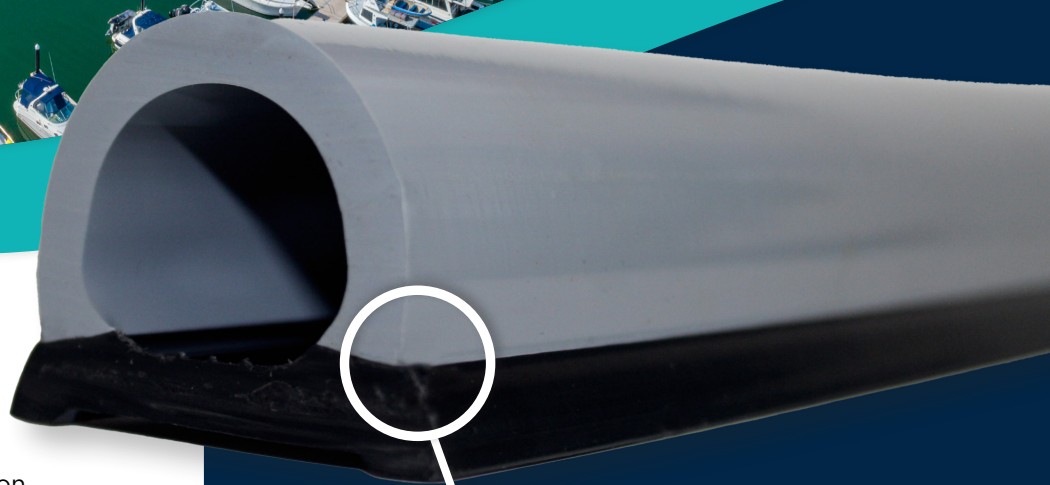

**SUPERIOR WELD**

### TOP

The top grey section of the fender has a simple and robust design. It is manufactured using a 95° duro non-marking, marine grade PVCn, which provides superior impact absorption. Anti-microbial additives and UV stabilisers are included for durability and longevity.

### RIGID BASE

The rigid black base eliminates the need for an aluminium fixing strap, which makes installation quicker and easier. It is manufactured using an impact modified, marine grade rigid PVC, which also contains UV stabilisers for durability and longevity.

**AUSTRALIAN MADE & MANUFACTURED**

# Our Products

IN STOCK AND READY TO ORDER

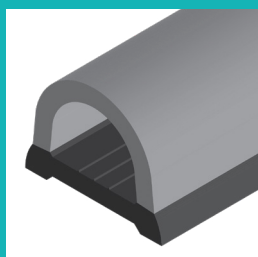

**Co-Extruded Fender**

45mm x 34mm\*

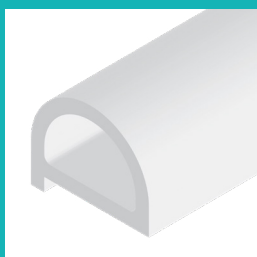

**D Fender with lip**

90mm x 65mm\*

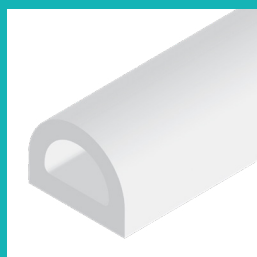

**Lightweight D Fender**

84mm x 66mm\*

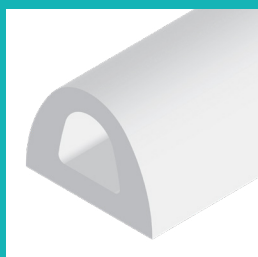

**Heavy Duty D Fender**

120mm x 90mm\*

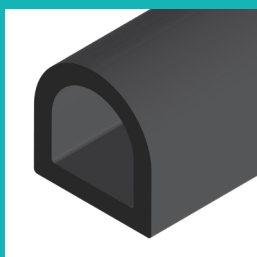

**Heavy Duty D Fender**

100mm x 100mm\*

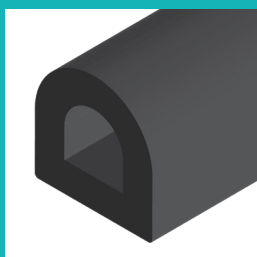

**Super Heavy Duty D Fender**

150mm x 150mm\*



## CUSTOM DESIGN AVAILABLE

Can't find what you're looking for?  
We can also custom design high performance fenders to suit your project requirements.

\*Dimensions are nominal.

## Key Features



**EXTEND ASSET LIFE**



**LOW MAINTENANCE**



**BEST PRACTICE MATERIALS**



**SIMPLE INSTALLATION**



**ROBUST AND DURABLE DESIGN**

AUSTRALIAN MANUFACTURER WITH OVER 30 YEARS EXPERIENCE